

DH-PFA142

Outdoor Surveillance Box



Features

- All-aluminum shell design, IP66, IK10
- Satisfy the installation of power supply, switch, MNVR and protective devices
- Optional fans for high temperature heat dissipation
- Tamper alarm function with an optional alarm switch
- Aesthetic design, easy installation

Camera Mount Series | DH-PFA142

Technical Specification

Model	DH-PFA142
General	
Material	Aluminum & SECC
Dimension (WxHxD)	450mmx365mmx191mm (17.72"x14.37"x7.52")
Weight	9kg (19.84lb)
Load Bearing (front)	10kg (22.05lb)
Load Bearing (side)	6kg (13.23lb)
Load Bearing (inside)	5kg (11.02lb)
Color	White
Operating Temperature	-40 °C ~+60 °C (-40 °F ~+140 °F)
Humidity	0~90% RH
Installation	Wall mount
Applicable Model	Please see "Accessory Selector" on www.dahuasecurity.com

Ordering Information

Type	Part Number	Description
Camera Mount Series	DH-PFA142	Outdoor surveillance box
	PFA142	Outdoor surveillance box

Dimension(mm/inch)

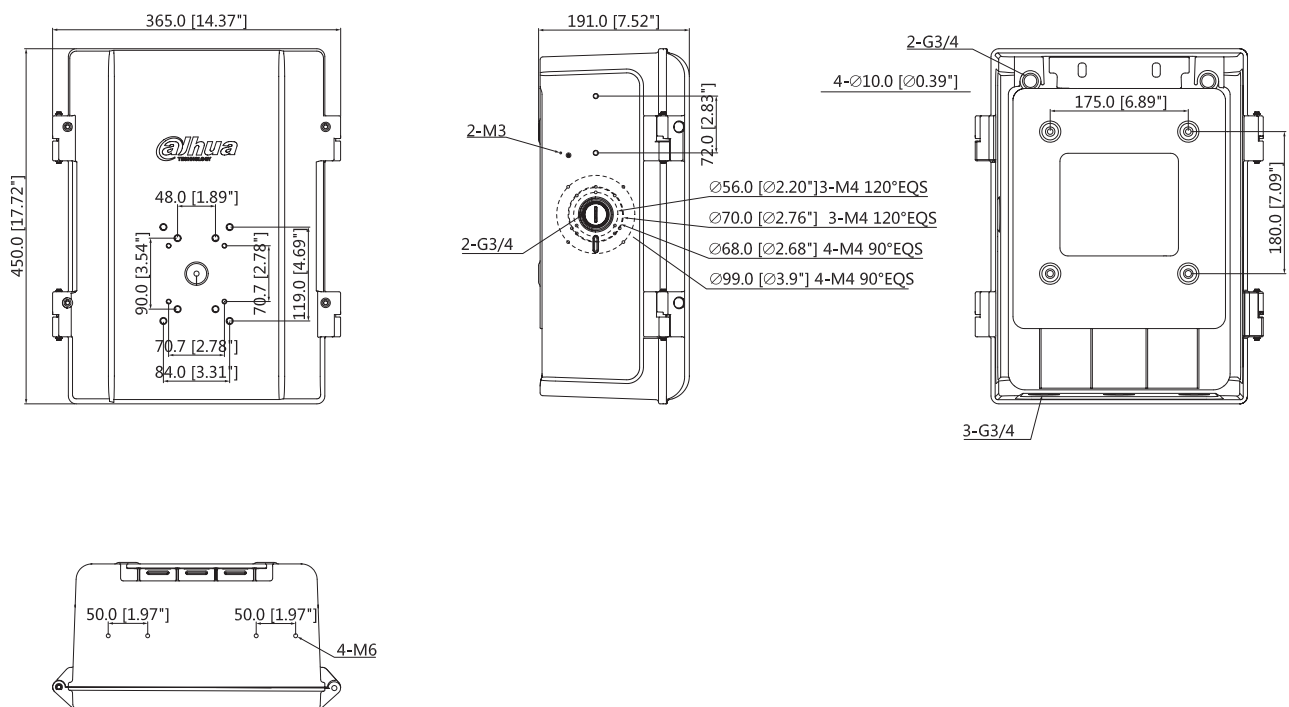

Application

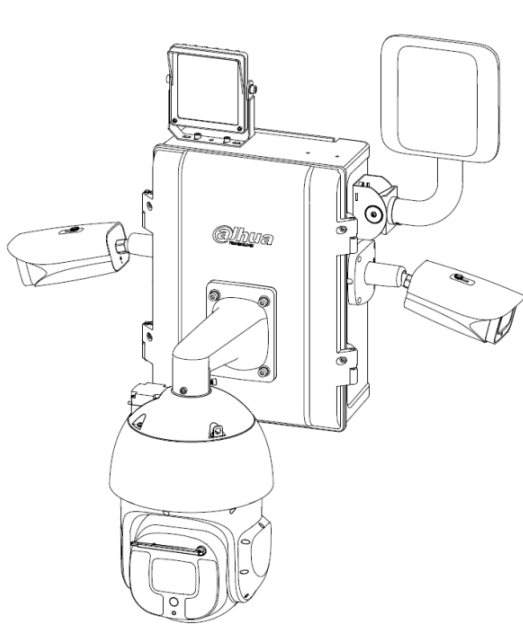

Wall mount

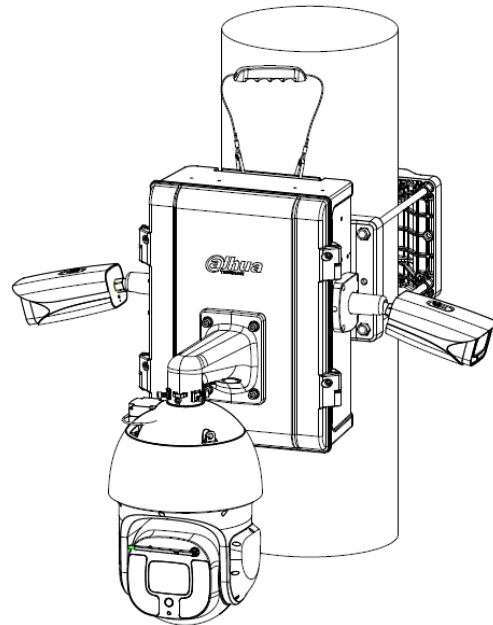

Pole mount

Package Information

- Outdoor surveillance box DH-PFA142 *1
- M8x80 expansion bolt *4
- M8x30 screw *4
- M6x10 bolt *8
- M4x10 screw *8
- M4x14 screw *4
- M4x8 screw *6
- M3x8 screw *2
- S3.0 wrench *1
- S5.0 wrench *1
- S6.0 wrench *1
- Water joint *5
- Sealing plug *2
- Sealing ring *1
- Assistant handle *1
- Terminal block *2
- Rail block *3
- User manual *1